



## Description

The duct humidistat HD1 is controlling the relative humidity in pipes and air ducts, in commercial or industrial applications and can drive fans, humidifiers or dehumidifiers bringing the moisture level of the value set on his knob. It comes supplied with plastic bracket for wall mounting and gasket for mounting on air ducts.

## Technical specifications

<b>Sensible element</b>	Stabilised synthetic textile tape, temperature-compensated
<b>Wiring terminals</b>	Screw terminals for wires up to 1,5 mm <sup>2</sup>
<b>Electrical rating</b>	Max 5 (3) A, 250 V AC Min 100 mA, 24 V
<b>Working range</b>	15...95% RH
<b>Differential</b>	4% RH
<b>Accuracy</b>	±5% RH*
<b>Max. air speed</b>	10 m/sec.
<b>Long term stability</b>	Approx. -1,5% RH/year
<b>Working temperature</b>	0...70 °C
<b>Storage temperature</b>	-25...70 °C
<b>Materials</b>	Housing of flame-retardant thermoplastic
<b>Protection type</b>	IP30
<b>Protection class</b>	II
<b>Action</b>	Type 1C. According EN 60730
<b>Pollution degree</b>	2. According EN 60730
<b>Rated impulse voltage</b>	4000V According EN 60730
<b>Temperature for the ball pressure test:</b>	125°C. According EN 60730



(\* ) The setting accuracy of the humidistat at the calibration point is ± 5% rh at 55% rh, 23°C after initial calibration at the factory. Setting accuracy see diagram "Setting accuracy". In general, humidity sensors (humidistats) are subject to increased ageing if they are used and/or stored in very contaminated air or aggressive gases. Under these conditions, the humidistat may drift prematurely and alter the linearity.

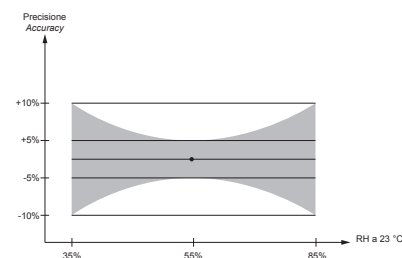

## Operation

When the relative humidity rises and reaches the upper switching point, contacts 1-2 open and 1-3 close. The setpoint corresponds to the upper switching point. The contacts revert to their original position when the humidity has fallen below the upper switching point by the amount of the fixed switching difference ( $\Delta$ ) of 4% RH.

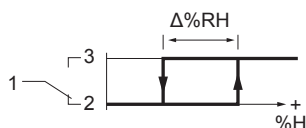

## Electrical wirings

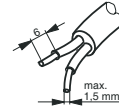
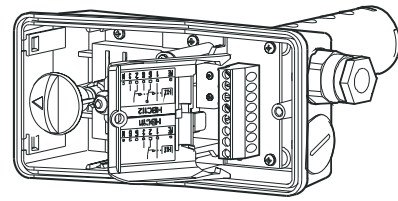
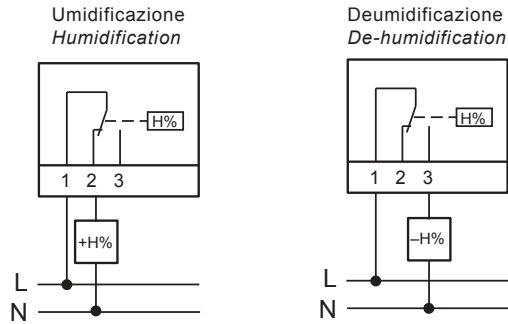

## Installation

### ⚠ DANGER

Electrical connection

Danger of electrocution! The removal of this cover exposes parts which carry mains voltage.

- The unit should be opened only by a qualified electrician or by the manufacturer's service personnel.
- Before starting any work on the electrical connections, separate the unit from the mains power supply.
- Do not apply power to the unit until it has been completely re-assembled and the housing has been closed.
- To prevent access by unqualified persons and, in particular, children, do not leave the opened unit unattended.

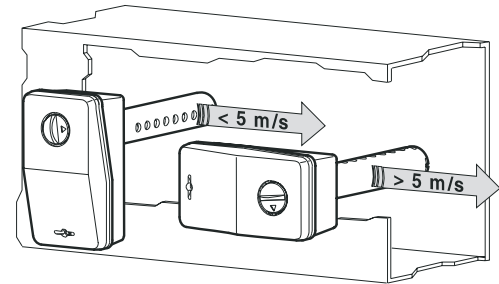
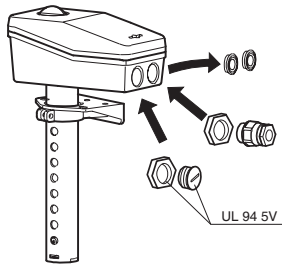
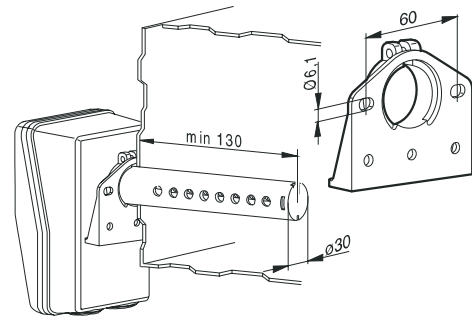
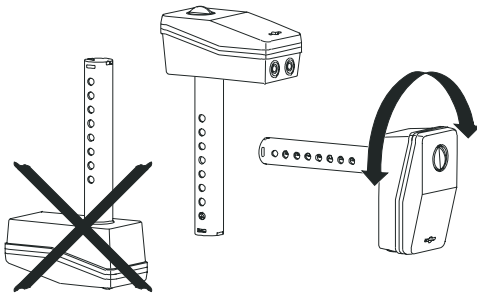

## Dimensions

